

# HULO CARD HOLDER

## ARCHITECTURAL SPECIFICATIONS

**MATERIAL: ZINC ALLOY 5**

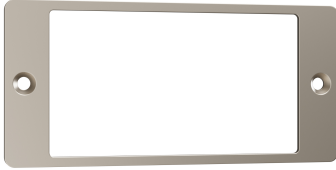

• **PART NUMBER:**  
HULO-CHOLD-SN

• **FINISH (STANDARD):**  
Satin Nickel

• **FINISHING PROCESS:**  
Electroplating

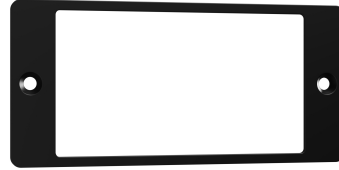

• **PART NUMBER:**  
HULO-CHOLD-MB

• **FINISH (PREMIUM):**  
Matte Black | Munsell N2

• **FINISHING PROCESS:**  
Electrodeposition Coating



• **PART NUMBER:**  
HULO-CHOLD-MW

• **FINISH (PREMIUM):**  
Matte White | Munsell N9

• **FINISHING PROCESS:**  
Epoxy Painting

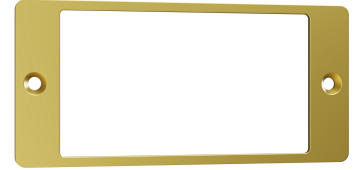

• **PART NUMBER:**  
HULO-CHOLD-SG

• **FINISH (PREMIUM):**  
Satin Gold | Pantone #871C

• **FINISHING PROCESS:**  
Epoxy Painting

10% color discrepancy, and custom pricing options apply.

- **MATERIAL:** Zinc Alloy 5
- **FINISHES:** Satin Nickel, Matte Black, Matte White, Satin Gold
- **INCLUDED:** Satin nickel screws (quantity: 2)
- **TESTED:** Rust-resistant and perfect for humid environments

- **MINIMUM CARD SIZE:** 48mm (1.88") x 86mm (3.38")
- **MAXIMUM CARD SIZE:** 52mm (2.04") x 89mm (3.50")
- **MAXIMUM CARD THICKNESS:** 1.5mm (0.05")
- **CLEANING:** When disinfecting, mist with at least 70% alcohol solution in order to maintain product integrity

### FRONT VIEW

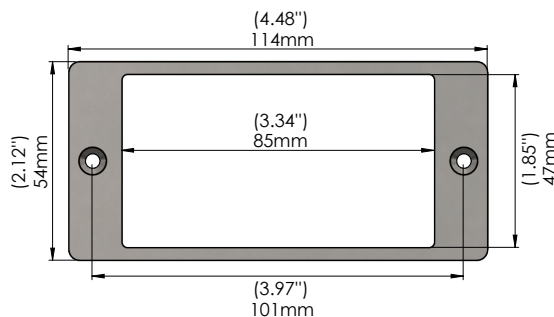

### TOP VIEW

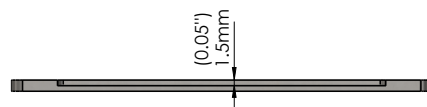

### BACK VIEW

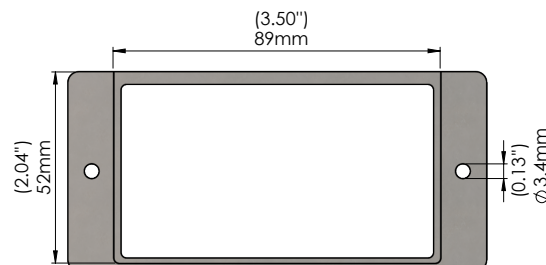

### SCREWS (SUS 304)

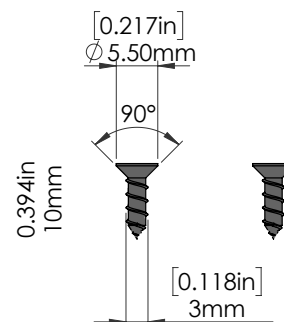

Manufactured By:

**KEYLESS.CO**

1825 W. Walnut Hill Ln., Suite 102, Irving, TX 75038, USA | +1 972-331-2770 | info@keyless.co | www.keyless.co | V: 3/4/2021